

TruLaser Tube

Tubes prefer
TRUMPF

Accelerate growth with laser tube cutting

The world we live in is growing. And with it the demand for products on a large scale and in a wide range of materials. Tubes are an elementary part of this. With high growth rates, the market for laser-cut tubes offers exceptionally good chances of success. Choose laser tube cutting to stay on the cutting edge in the future.

The possibilities of technology

We are living in a world of tubes
4–5

Advantages compared with conventional tube cutting

Why process tubes with lasers?
6–7

Flexible and cost-efficient manufacturing

**Redesign and save on costs
8–11**

The right software

**Your product range
for the world of tubes
12–13**

Integrated components for best results

**Functions that take
you forward
14–15**

The TruLaser Tube family

**The right machine for you
16–27**

There for you: our services

**TruServices.
Your Partner in Performance
28–29**

Networked production

**TruConnect –
Your Smart Factory
30**

We are living in a world of tubes

What does an intricate designer lamp share with the sturdy frame of a combine harvester or the complex tubular system of a scaffold? They are all produced from laser-cut tube and profile designs. No wonder, because no tool is as versatile and offers as much contouring freedom as a laser. You can find evidence of it in furniture, cars, commercial vehicles, transport, on construction sites, in mechanical engineering and plant construction, in agriculture, in the fitness industry, climate and energy technology, or in shopfitting.



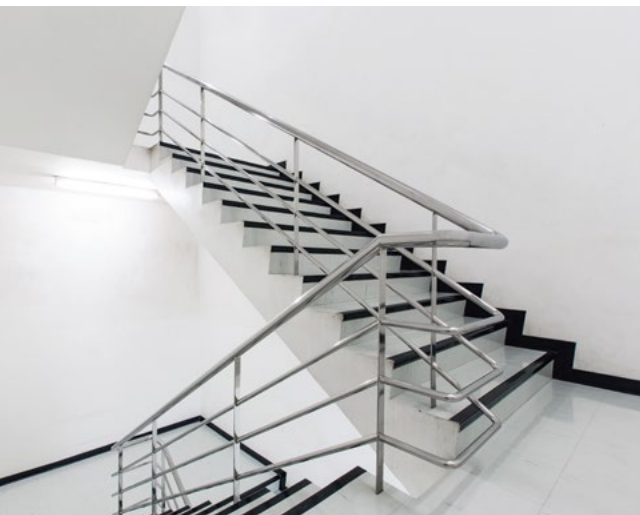

Why process tubes with lasers?

No need for sawing, drilling or deburring: Compared with conventional tube cutting the laser replaces a number of work steps. It can cut very precisely complex contours in materials such as mild steel, stainless steel, aluminum or nonferrous metal. Laser tube cutting offers a wide range of design options, opening the door to new products, customers, and orders.



"Laser tube cutting offers new design options for tube manufacturers to delight their customers. Innovative designs also offer a great potential for savings."

Norbert Beier, Head of Sales Laser Tube Cutting



Make full use of versatile contouring options

You can cut every conceivable contour with a laser beam. At the same time, machines are easy to use – your design options are almost unlimited.

Cost-effective manufacturing

Carry out several different work steps on a single machine, manufacturing parts precisely and quickly.

Save on tools

With the laser tool you can process different types of materials, wall thicknesses, and profile geometries in a completely noncontact procedure. Save time and money as there is no need to change tools.

Comparison of work steps for laser tube cutting and conventional production

Conventional production

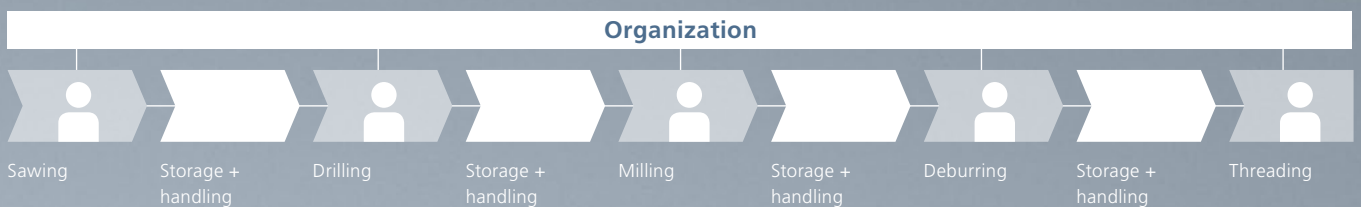

Laser tube cutting



Redesign and save on costs

Innovative tube designs save time and give you the technical edge: With bending frames, for example, you will need fewer parts. Positioning aids facilitate error-free assembly. The amount of work required for downstream work steps, for example welding, is noticeably reduced. And all this with just one machine.

How can you optimize your parts? Speak with our expert consultants on parts design to receive a wide range of tips that are tailored to your exact needs. Ready for optimal parts design?

Easier positioning, connecting and assembling

Clever designs with laser tube cutting simplify your processes: prepare your parts perfectly for subsequent work steps.

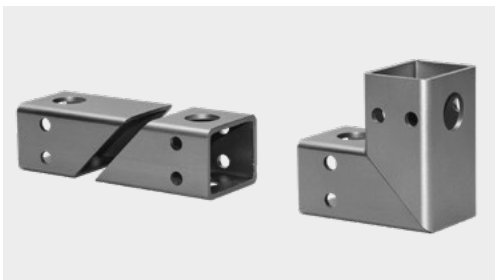

Thanks to bevel cuts of up to 45°, you can further process corner connections more quickly – with optimal material utilization.



Use tube-blank connections for simple fixing, optionally with lugs or coding function.

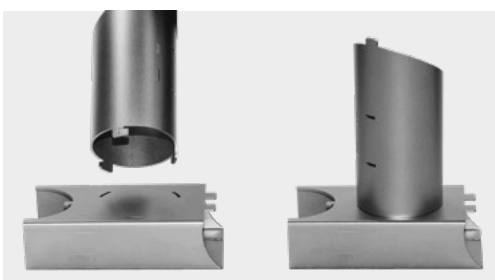

Replace time-consuming welding fixtures with plug, dovetail and bayonet connections.

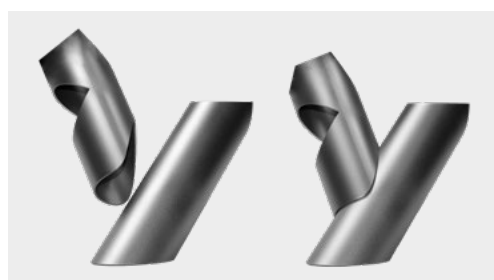

Connect tubes together easily using attachments – the perfect option for load-carrying tube designs.

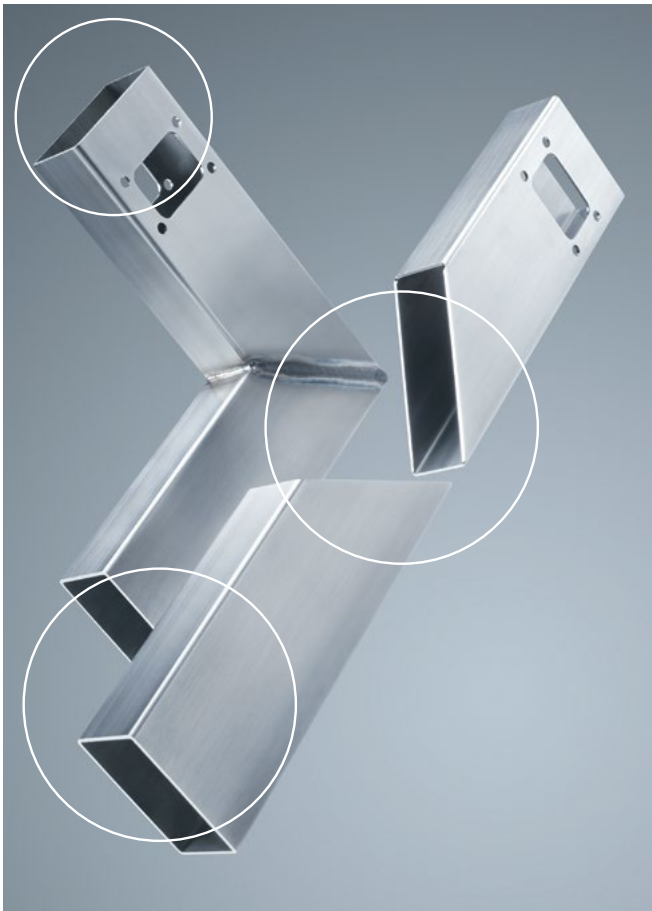

Conventionally welded from two single parts.





Efficient production of bend connections and positioning aids with a laser.

Increased technical advantages, reduced parts costs

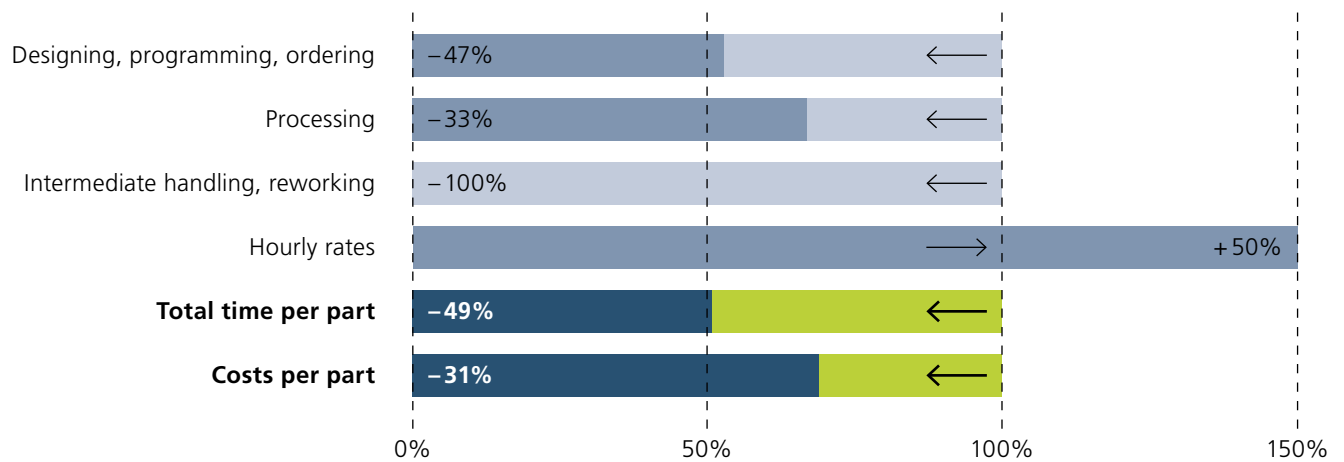
Get straight to the bottom line: thanks to bend connections, recesses and pins, you can reduce the time needed to make this sample part by 49% and the cost by 31%.



 Laser tube cutting with TruLaser Tube

 Conventional production (sawing, milling, drilling)

Better utilization for greater profit

Would you like to increase your vertical range of manufacture, improve your machine utilization rate, or lower the costs for fixtures? Then you should manufacture fixtures from laser-cut tubes in the future. It's easier than you think.

Tube fixture design

Simply produce your own fixtures

The design of tube fixtures allows you to tap into an additional application field, and utilize more of your laser tube cutting machine's capacity. Learn about the design rules for tube fixtures and how you can optimally design your assemblies through training sessions and consultations. These will allow you to design, adapt, and replicate assemblies quickly and cost-effectively in the future.

The example shows that while the conventionally manufactured welding fixture needs to be laboriously adjusted via a clamping device, the new design features a spring effect for tolerance compensation.

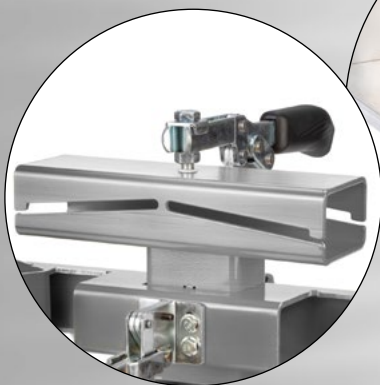

Optimized fixture made from tubes



Conventionally milled fixture

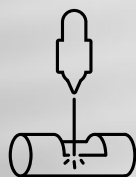

Laser tube cutting

parts, including all inner geometries and joining aids in pin form

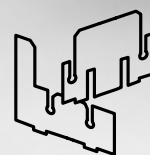

Assembling

and welding the two single parts





Cleverly designed welding fixture

Ergonomic solution including spring effect and tolerance compensation

A tube plug-in design replaces the entire milling block. The laser tube cutting machine not only cuts the tube cross section to size, it also provides all parts with joining aids, which allow for precise positioning. The laser tube cutting machine also creates threads directly.



You benefit from fewer parts and less effort. Only one clamping device is required in the upper clamping tube. The visible longitudinal sections provide a spring effect to the fixture and compensate for the tolerances in the component. The vertical design of the fixture makes it easily accessible and ergonomic. The entire welding assembly can now be welded in one clamping, in the exact size, and with higher quality. All in all, the manufacturing time and weight are reduced.

-80%
in costs

Your product range for the world of tubes

The 3D software Programming Tube takes you quickly, easily and intuitively to the NC program. Thanks to strong automatism, no programming is required for many finished parts. Numerous cases, for example automatic production of innovative bend connections and positioning aids, are already stored. The software solution also offers flexible data import and powerful design, supporting you throughout the entire programming process.

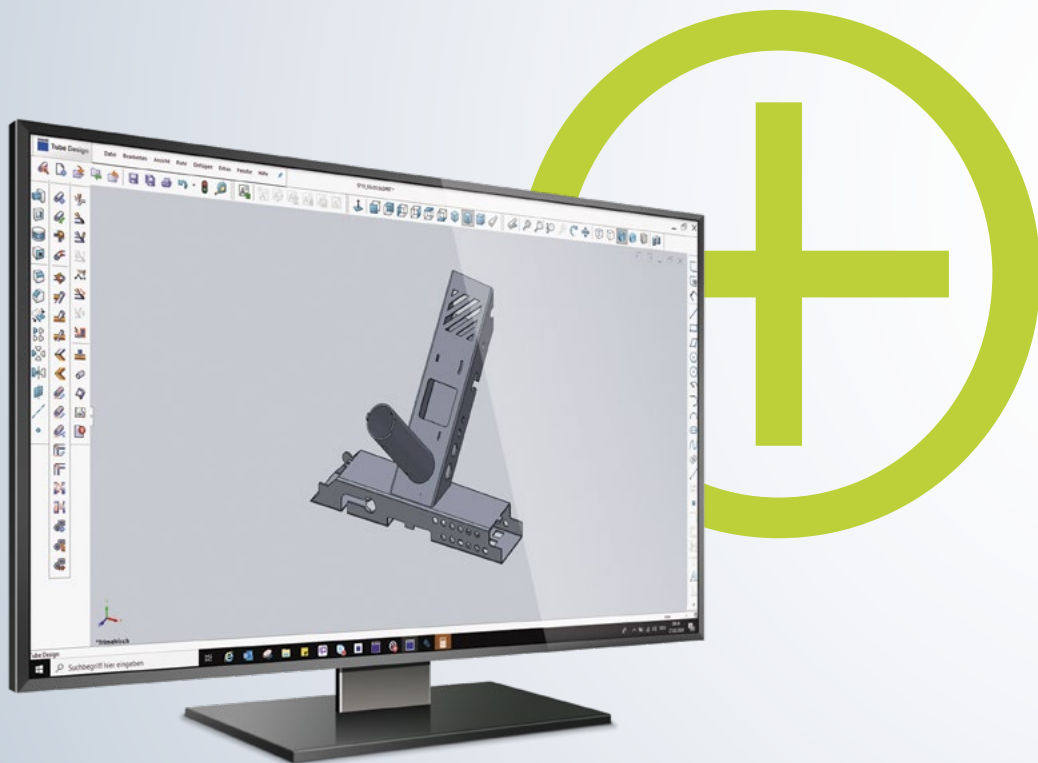

Programming Tube

- Programming system for tube and profile processing
- Strong automatism: Parts already programmed when loading
- Easy to learn thanks to modern, intuitive user interface
- Direct manipulation: Change processing directly in 3D
- Optimize parameters in the running simulation
- Preset rules and TRUMPF cutting data

Automatic programming of threads

Based on the thread parameters, Programming Tube automatically creates the NC program including tools and processing sequence.

Flexible data imports

Import all common formats in Programming Tube. The program corrects incorrect data as well as rounding radii and splits up their assemblies.

Adding tube connections

Design positioning aids and bend connections with just a few clicks of the mouse and reduce your rejects. Positioning aids simplify downstream work steps such as mounting or welding. Bend connections help you to connect tubes more precisely and quickly.

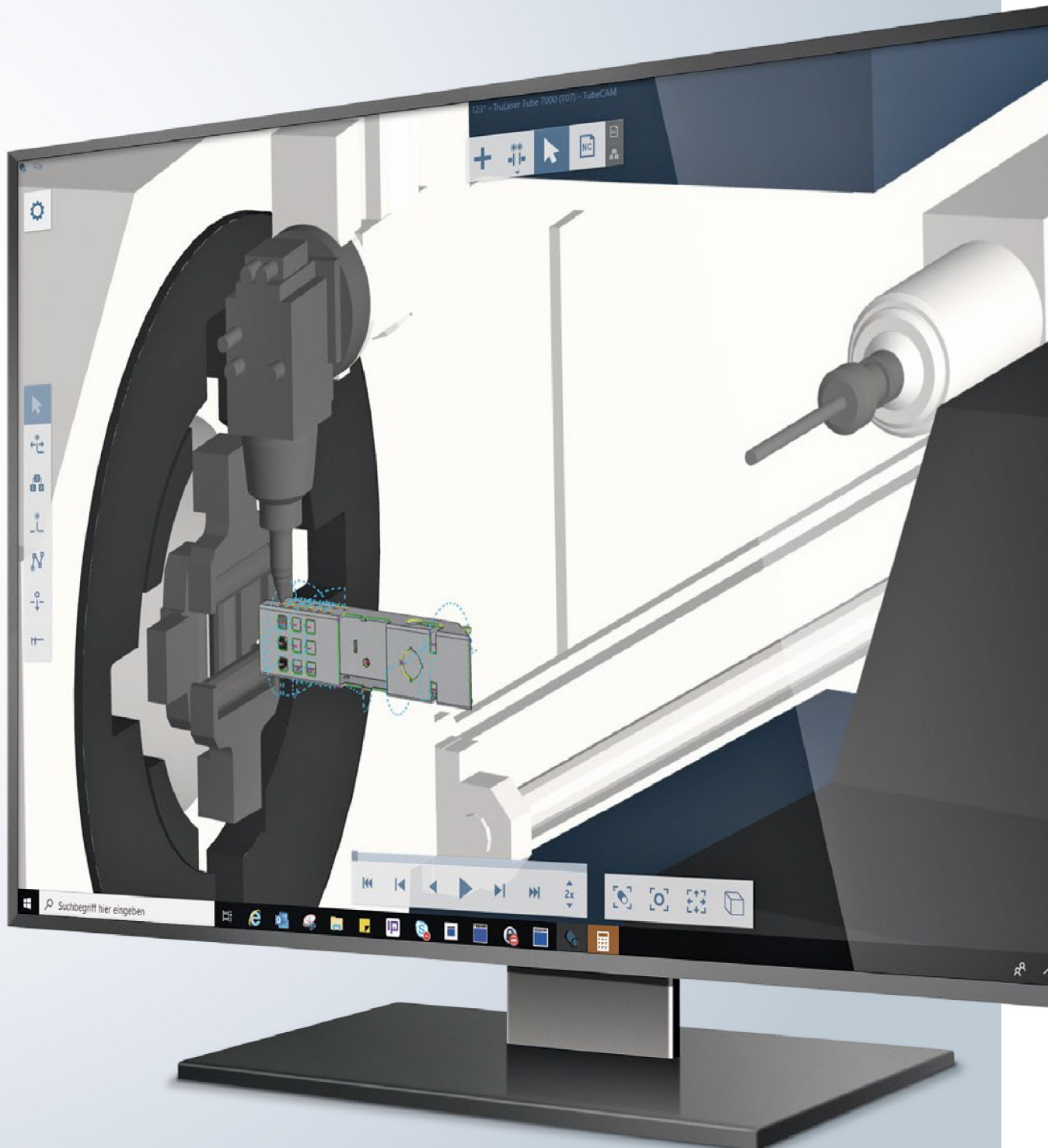

Functions that take you forward

With clever functions and integrated expertise, your TruLaser Tube simplifies the path of your tubes and profiles through the machine. From loading to cutting and unloading to downstream processes, the purpose is clear: to help you build on your competitive edge.



- **Safe and automatic loading** even of special profiles – Smart Profile Detection detects the position and orientation of the profile with the help of sensors and adapts the cutting program accordingly.
- **Automatic tube alignment** is carried out by SeamLine Tube. It detects weld seams or markings and aligns the tube suitable to the cut geometry.
- **Quick and efficient manufacturing of small lot sizes is** facilitated by the pivoted manual conveyor system. Loading is automatic and also perfectly suited to special profiles.



- **Productive manufacturing of material thickness up to 3 mm** using the function RapidCut. It uses the high feed rates of the solid-state laser even with small contours, allowing you to process your parts up to 30% faster.
- **Reduce piercing times** with PierceLine, depending on the material type and thickness, by 10–60% compared to preset values.
- **One cutting head for all wall thicknesses** is all you need thanks to the single cutting head strategy of TRUMPF.
- **Protect the cutting head and avoid collisions** using the Controlline function – the distance between the cutting nozzle and the surface remains constant, even with uneven tube surfaces. The magnetic coupling minimizes the impact of unavoidable collisions.
- **Reduce rejects and material costs** with the help of AdjustLine. It helps you cut even lower quality material quickly and easily.
- **Adapt the focus position to the material type and thickness** using the automatic FocusLine function.



- **Sort parts according to orders** with the help of wire mesh boxes, customer-specific containers, or conveyor tables which protect your materials.
- **Automate loading and unloading even further** using the digital unloading interface, for example by connecting a robot.



- **Prepare bevel edges optimally** using the bevel cut function with patented TRUMPF technology for high-quality bevel cuts up to 45°.
- **Apply threads in a single work step** using the technology package for tapping directly on your machine. Using an NC-controlled spindle unit, you can carry out processes such as twist drilling, thread cutting, flow drilling, and tapping.
- **Clean inside of tubes** are ensured by the spatter protection device for round tubes, avoiding the need for reworking.
- **Identify your parts** easily using a Dot Matrix Code.

The right machine for you

Laser tube cutting requires advanced technology, coordinated components and a service network at your side. That's why, at TRUMPF, we develop the machine, laser, software and automation in-house. We manufacture all the important components for the machining process ourselves, making sure you get the best possible results.

Which machine meets your requirements? Find out more about the TruLaser Tube family on the following pages.



Find out more information here about our laser tube cutting product portfolio:
https://www.trumpf.com/en_INT/products/machines-systems/laser-tube-cutting-machines/





TruLaser Tube 3000 fiber

The machine that's always worth it for laser tube cutting.



01

Cost-effective

even when it is not fully utilized

02

Reliable

thanks to robust design and intelligent functions

01

Cost-effective

even when it is not fully utilized

Whether you want to insource quality, require flexible manufacturing to tight deadlines, or want to win new customers and markets: this machine pays for itself, even if you don't utilize it fully.

02

Reliable

thanks to robust design and intelligent functions

No need for time-consuming manual setting of the machine that is more likely to cause errors, as the machine automatically performs many of the tasks itself. It uses ControlLine to avoid collisions and AdjustLine to cut lower quality material safely. Thanks to FocusLine, the focus is always in the right place.

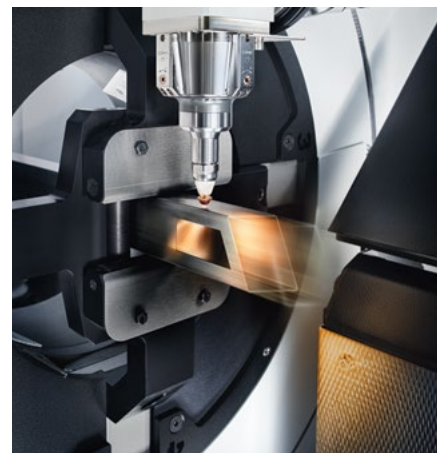

Max. outside diameter of round tube in mm: 152^[1]
 Max. outer circle diameter of rectangular tube in mm: 170
 Max. workpiece weight in kg/m: 18.5 (120/148 kg total)^[2]



03

Easy
to handle

04

Precision
cutting and clamping

03

Easy
to handle

Easy to operate: minimal setup times, outstanding accessibility – so that you never lose sight of the process. Loading and unloading can easily be carried out manually or automatically using LoadMaster Tube, crane, or part removal flap.

04

Precision
cutting and clamping

Its precision matches that of the 5000 and 7000 series: high-precision clamping system, exact optics setup and precise tube guidance for best part quality. Thanks to the adaptive clamping system, you can process L- and U-profiles yourself.

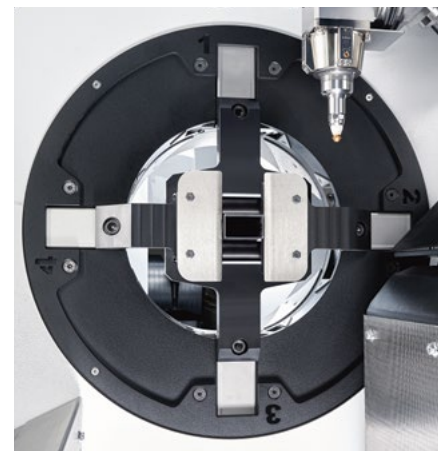

More information about the TruLaser Tube 3000 fiber can be found here:
https://www.trumpf.com/en_INT/products/machines-systems/laser-tube-cutting-machines/trulaser-tube-3000-fiber/



TruLaser Tube 5000 fiber

Solid-state laser technology for fast and flexible processing. The TruLaser Tube 5000 fiber uses these strengths more than any other laser tube cutting machine has ever done before.



01

Highly productive

with solid-state laser and RapidCut

02

Setup-free

thanks to clamping system

01

Highly productive

with solid-state laser and RapidCut

Thanks to RapidCut, the high feed rates of the solid-state laser come into their own even with smaller contours. With thin material in particular, this is a huge productivity advantage.



With RapidCut, you can reduce part cutting times for material thicknesses of up to 3 mm.

02

Setup-free

thanks to clamping system

Setup is so outmoded – the clamping system of the TruLaser Tube 5000 fiber lets you produce tubes in the entire standard clamping range with no setup. The step rollers automatically adjust to the different diameters of the pipes.

^[1] Manual loading of round tubes with outside diameter of 152 to 170 mm optionally possible. ^[2] Max. outer circle diameter of rectangular tube 180 mm optionally possible. Rectangular profiles with side length > 152.4 mm only with manual loading. ^[3] Value for larger versions (option). Content subject to change without notice. Only specifications in our offer and order confirmation are binding.

Max. outside diameter of round tube in mm: 152^[1]
 Max. outer circle diameter of rectangular tube in mm: 170^[2]
 Max. workpiece weight in kg/m: 25 (162.5/200 kg total)^[3]

04

Easily expandable

for follow-up processes such as tapping

03

Perfectly accessible

thanks to intelligent beam guard

03

Perfectly accessible

thanks to intelligent beam guard

Tube processing by solid-state laser is not only possible with a complete housing – the open machine concept makes your TruLaser Tube 5000 fiber optimally accessible. Load and unload individual tubes quickly and easily from the front.



04

Easily expandable

for follow-up processes such as tapping

Easily integrate further processes: With the technology package for tapping, you can carry out machining processes such as flow drilling, tapping, and twist drilling. In the laser network, you can operate several TRUMPF machines with one laser.



More information about the TruLaser Tube 5000 fiber can be found here:
https://www.trumpf.com/en_INT/products/machines-systems/laser-tube-cutting-machines/trulaser-tube-5000-fiber/



TruLaser Tube 5000

Open and modular down to the last detail – the machine concept has proven its worth in day-to-day industrial processes worldwide.



01

Open design

keep an eye on everything,
at all times

02

Modular installation

customized to your requirements

01

Open design

keep an eye on everything, at all times

Due to the machine's open design, the operator can keep an eye on the entire process at all times. The exceptional accessibility makes it possible for individual tubes to be loaded and unloaded quickly.

02

Modular installation

customized to your requirements

Install your TruLaser Tube in line with your requirements. Here, you can place the LoadMaster Tube either in front of or behind the machine, as desired. You can set up conveyor tables, wire mesh boxes, and containers on the unloading side.

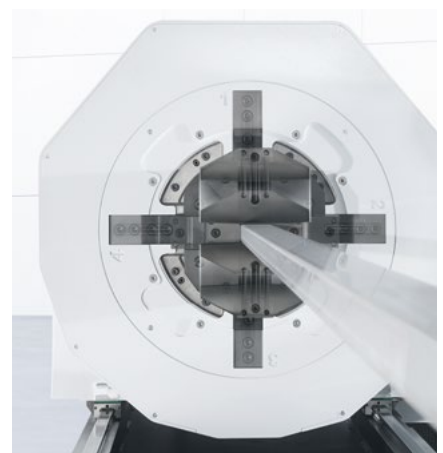

Thanks to the innovative clamping system, you can produce with virtually no setup.

Max. outside diameter of round tube in mm: 152^[1]
 Max. outer circle diameter of rectangular tube in mm: 170^[2]
 Max. workpiece weight in kg/m: 25 (162.5/200 kg total)^[3]

04

Reduced part costs

thanks to integration of follow-up processes

03

Minimum idle states

with clamping system that does not require setup

03

Minimum idle states

with clamping system that does not require setup

Setting up means increased expense – especially for small lot sizes. Thanks to the innovative clamping system of your TruLaser Tube 5000, you can produce tubes in the entire standard clamping range with virtually no setup. The step rollers automatically adjust to the different diameters of the pipes.

04

Reduced part costs

thanks to integration of follow-up processes

By integrating upstream and downstream processes into the TruLaser Tube 5000, you save time and money. For example with the technology package for tapping, you can produce threads even in thin materials, due to flow drilling. You avoid having to travel from one machine to the next and in doing so, reduce part costs and the risk of errors.



More information about the TruLaser Tube 5000 can be found here:
https://www.trumpf.com/en_INT/products/machines-systems/laser-tube-cutting-machines/trulaser-tube-5000/



TruLaser Tube 7000 fiber

Highest level of productivity –
even for XXL tubes.



01

Dynamic and productive

with solid-state laser and RapidCut

02

XXL

tubes up to 254 mm diameter

01

Dynamic and productive

with solid-state laser and RapidCut

The superimposed movement of the tube axis and cutting head increases the dynamics of your machine by more than four times. Thanks to RapidCut, the high feed rates of your solid-state laser come into their own even with smaller contours. With thin material in particular, this is a huge productivity advantage.



With RapidCut, you can increase the acceleration by up to four times.

02

XXL

tubes up to 254 mm diameter

Whether large or small, thick or thin: With your TruLaser Tube 7000 fiber you can cut a broad spectrum of parts. This includes even extra-large tubes and profiles with diameters up to 254 mm, and wall thicknesses of up to 10 mm for mild steel.

Max. outside diameter of round tube in mm: 254
 Max. outer circle diameter of rectangular tube in mm: 254
 Max. workpiece weight in kg/m: 40

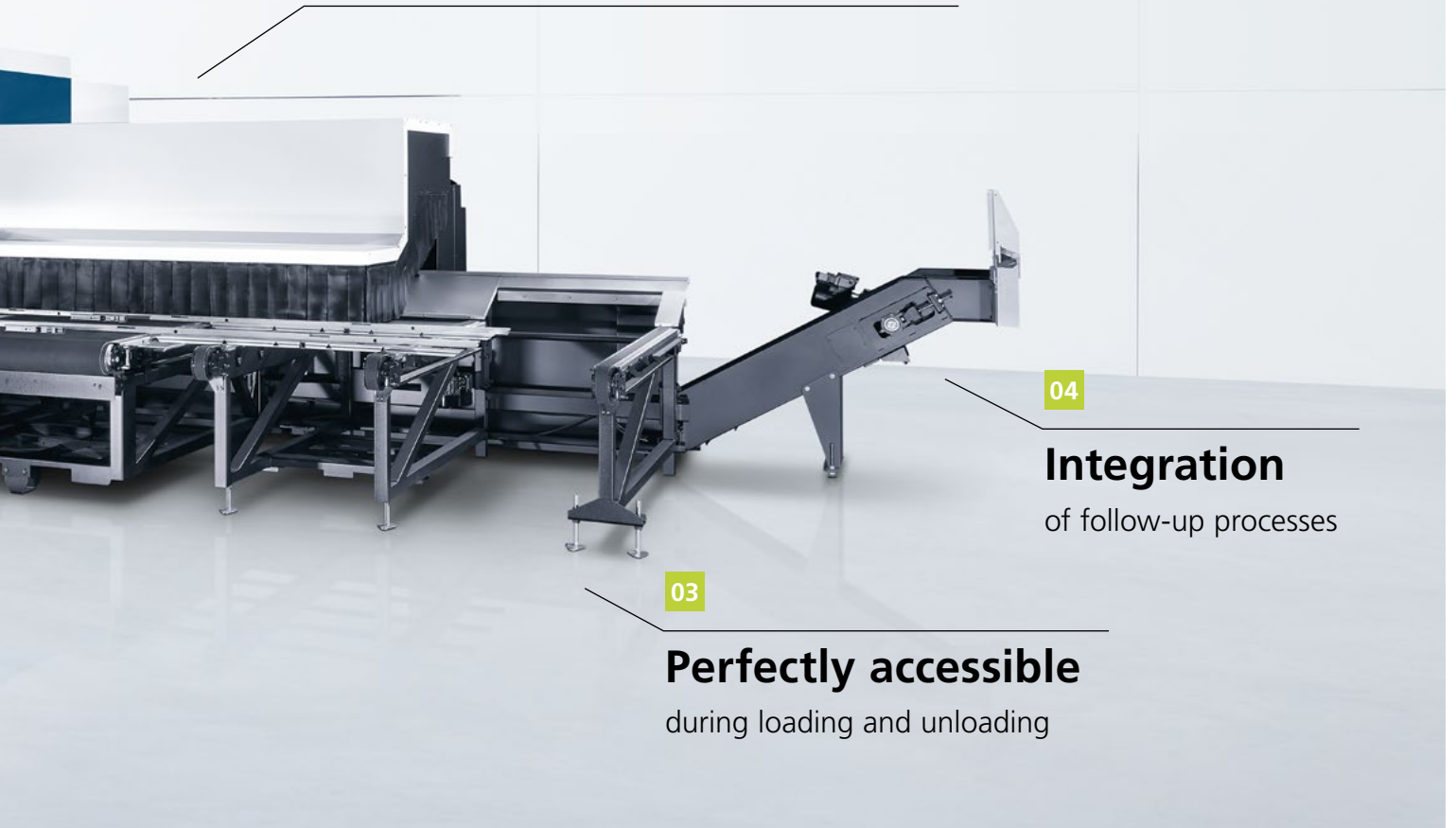

04

Integration
 of follow-up processes

03

Perfectly accessible
 during loading and unloading

03

Perfectly accessible
 during loading and unloading

The open machine concept makes your TruLaser Tube 7000 fiber optimally accessible. This allows you to load individual XXL tubes – for example by crane – quickly and efficiently. For small lot sizes and special profiles you can use the swivel-mounted conveyor system.



04

Integration
 of follow-up processes

Carry out follow-up processes on your machine with ease: With the optional technology package for tapping, for example, you can carry out machining processes such as flow drilling, tapping, and twist drilling – automatically.



More information about the TruLaser Tube 7000 fiber can be found here:
https://www.trumpf.com/en_INT/products/machines-systems/laser-tube-cutting-machines/trulaser-tube-7000-fiber/



Technical data

Here is the technical data for our TruLaser Tube machines and an overview of the availability of intelligent functions.

Laser data		TruLaser Tube 3000 fiber		TruLaser Tube 5000 fiber		TruLaser Tube 7000 fiber	
		TruFiber 2001		TruDisk 3001	TruDisk 4001	TruDisk 3001	TruDisk 4001
Max. power	kW	2		3	4	3	4
Average power input in production	kW	6		9	10	9	10
Max. material thicknesses							
Mild steel	mm	8		8	10	8	10
Stainless steel	mm	4		5	6	5	6
Aluminum	mm	4		6	6	6	6
Copper/brass	mm	3		4	5	4	5

Content subject to change without notice. Only specifications in our offer and order confirmation are binding.

Laser data		TruLaser Tube 5000		
		TruFlow 2000	TruFlow 2700	TruFlow 3200
Max. power	kW	2	2.7	3.2
Average power input in production	kW	17.5	20	24
Max. material thicknesses				
Mild steel	mm	8	10 ^[1]	10 ^[1]
Stainless steel	mm	4	5	5
Aluminum	mm	3	4	4

^[1]With PierceLine (option).

Content subject to change without notice. Only specifications in our offer and order confirmation are binding.

Available functions/options	TruLaser Tube 3000 fiber	TruLaser Tube 5000 fiber	TruLaser Tube 5000	TruLaser Tube 7000 fiber
AdjustLine	■	■		■
Digital loading and unloading interface	■	■	■	■
Dot Matrix Code	■	■	■	■
Conveyor system	■ (nonswiveling)	■ (nonswiveling)	■ (nonswiveling)	■ (swiveling)
Magnetic coupling/Controlline/FocusLine	■	■	■	■
PierceLine		■	■	■
RapidCut		■		■
Bevel cut		■	■	■
SeamLine Tube	■	■	■	■
Smart Profile Detection		■	■	■
Sorting function unloading point				■
Spatter protection device				■
Technology package for tapping		■	■	■

TruLaser Tube 3000 fiber		
Max. outside diameter of round tube	mm	152 ^[1]
Max. outer circle diameter of rectangular tube	mm	170
Max. unprocessed material length for automatic loading	mm	6500 8000 ^[3]
Max. finished part length	mm	3000 4500 ^[3]
Max. workpiece weight	kg/m	18.5 (120 148 ^[3] kg total)
Available lasers		TruFiber 2001

Content subject to change without notice. Only specifications in our offer and order confirmation are binding.

TruLaser Tube 5000 fiber		
Max. outside diameter of round tube	mm	152 ^[1]
Max. outer circle diameter of rectangular tube	mm	170 ^[2]
Max. unprocessed material length for automatic loading	mm	6500 8000 ^[3]
Max. finished part length	mm	3000 4500 ^[3] 6500 ^[3] 8000 ^[3]
Max. workpiece weight	kg/m	25 (162.5 200 ^[3] kg total)
Available lasers		TruDisk 3001 TruDisk 4001

Content subject to change without notice. Only specifications in our offer and order confirmation are binding.

TruLaser Tube 5000		
Max. outside diameter of round tube	mm	152 ^[1]
Max. outer circle diameter of rectangular tube	mm	170 ^[2]
Max. unprocessed material length for automatic loading	mm	6500 8000 ^[3]
Max. finished part length	mm	3000 4500 ^[3] 6500 ^[3] 8000 ^[3]
Max. workpiece weight	kg/m	25 (162.5 200 ^[3] kg total)
Available lasers		TruFlow 2000 TruFlow 2700 TruFlow 3200

Content subject to change without notice. Only specifications in our offer and order confirmation are binding.

TruLaser Tube 7000 fiber		
Max. outside diameter of round tube	mm	254
Max. outer circle diameter of rectangular tube	mm	254
Max. unprocessed material length for automatic loading	mm	6500 9200 ^[3]
Max. finished part length	mm	4500 6000 ^[3] 6500 ^[3] 8000 ^[3]
Max. workpiece weight	kg/m	40
Available lasers		TruDisk 3001 TruDisk 4001

Content subject to change without notice. Only specifications in our offer and order confirmation are binding.

^[1] Manual loading of round tubes with outside diameter of 152 to 170 mm optionally possible. ^[2] Max. outer circle diameter of rectangular tube 180 mm optionally possible. Rectangular profiles with side length > 152.4 mm only with manual loading. ^[3] Value for the enlarged design (option).

TruServices. Your Partner in Performance

To ensure your future success, you need services that definitely put you ahead of the pack over the long term. Whether that means creating the best conditions for successful production or optimally using your TRUMPF laser tube cutting machine to adapt to changes with flexibility – together we will find ways to sustainably maximize your value creation. As a reliable partner, we will provide you with comprehensive solutions and service packages for your requirements – so that you can produce cost-effectively and at a constantly high level.

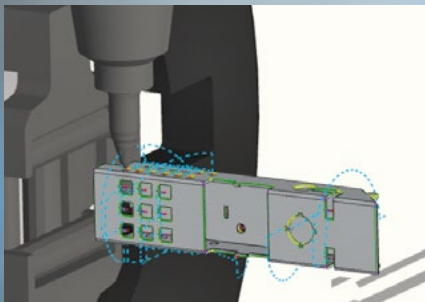

EMPOWER: If you want to create the best conditions for successful manufacturing: We will support you in this. The software system Programming Tube enables you to automatically create programs for your tube and profile designs. The easy-to-use programming makes your laser tube cutting machine especially productive.



SUPPORT: If you want to gradually gear your manufacturing to maximum value creation: We will work together to reach your goal. Use our comprehensive training program to expand your knowledge and get a competitive edge. Our experienced trainers share their tips and tricks when it comes to your TruLaser Tube machine and take you to the next level in the field of laser tube cutting.

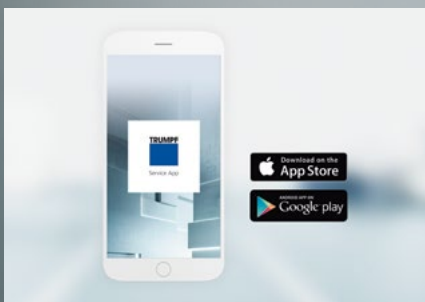

IMPROVE: If flexibility and availability of equipment in day-to-day operations are essential to you: We are there for you. Technical Service and the TRUMPF service network will assist you with any questions about your TruLaser Tube. Simply contact us, including using the Service app.



- | | | |
|---------------------------------|----------------------|-----------------------|
| Financing | Training Courses | Pre-owned Machines |
| Technical Service | Tools | Genuine Parts |
| Design and Programming Software | Process Optimization | Monitoring & Analysis |
| Product Enhancements | Value Packages | Service Agreements |



Learn more here about our complete and comprehensive package of useful services:
www.trumpf.com/s/services



TruConnect – Your Smart Factory

Gain more freedom with digital networking: You see more, know more, and get the best out of your production. With TruConnect, the synonym for Industry 4.0 at TRUMPF, you can design your Smart Factory step by step. The solutions from TRUMPF support you on your path towards your networked production, helping you to make the entire process more transparent, more flexible, and above all, more efficient.

For companies big and small

From the simple product solution right through to fully networked production

- **Start simply** with machines that are equipped for networking as standard.
- **Customize step by step** with automated machines or autonomous processing cells embedded in a production solution.
- **Enjoy full networking** with a continuous production solution, from order to delivery.

Smart functions and Industry 4.0

Due to the Central Link interface, your TruLaser Tube machine is ready for Industry 4.0. In addition, it contains various TRUMPF Machine Apps, which can be used to analyze and display machine data. This provides transparency – and shows you exactly where you can optimize processes.



80%

Indirect processes make up 80% of your production time – this is where the greatest potential for saving lies.



Discover what potential networked production offers you with two example scenarios: www.trumpf.com/s/smart-factory

Passion is what drives us

Whether it's production and manufacturing technology, laser technology, or material processing – we develop highly innovative products and services which are suitable for industry and absolutely reliable. We put everything we've got into giving you a compelling and competitive edge – expertise, experience, and a lot of passion.



Check out our YouTube page:
www.youtube.com/TRUMPFtube
www.trumpf.info/97b623

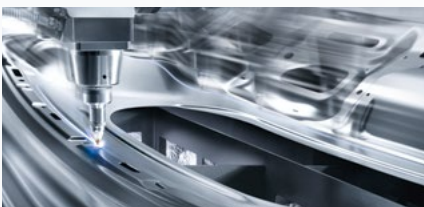

Lasers for manufacturing technology

Whether on a macro-, micro-, or nanolevel – we have the right laser and the right technology to produce innovatively and cost-efficiently in every industrial application. Beyond the technology itself, we support you with system solutions, application knowledge, and advice.



Power supplies for high-tech processes

From semi-conductor manufacturing to solar cell production: with our RF and MF generators, the current for induction heating, plasma and laser excitation is given a defined frequency and power – with high reliability and repeatability.



Machine tools for flexible sheet and tube processing

Whether it's laser cutting, punching, bending, or laser welding: we offer tailor-made machines and automation solutions, including consulting, software, and services for all processes in flexible sheet metal processing – so you can reliably manufacture your products to exacting quality standards.



TruConnect
Your Smart Factory

Industry 4.0

The TruConnect range of solutions links human and machine with information. It covers all steps in the production process – from the offer right through to the shipping of your parts.

TRUMPF is certified to ISO 9001
(Find out more: www.trumpf.com/s/quality)

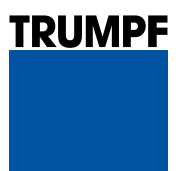

TRUMPF Werkzeugmaschinen GmbH + Co. KG
www.trumpf.com